

USA train series

Collectors Edition

Santa Fe SuperChief

1950

<506662>

Instructions

Suggested use



Comes with

First Car x 1

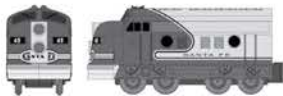

Motor Car x 1



Rear Car x 1



Stickers x 1



Straight train track x 3



Riser train track A x 1
Riser train track B x 1



Curve train track x 8



Bridge column x 7



Locking switch train track x 1



Steel Bridge

Steel Bridge Side x 4

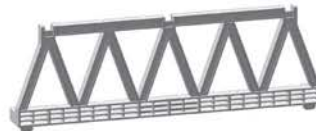

Steel Bridge Top x 2



Station

Station Roof x 1



Station wall A x 1



Station wall B x 1



Tunnel

Tunnel side A x 2



Tunnel side B x 2



How to use

How to insert battery

Insert battery into the Motor Car

- 1 Push the lock of the Train cover to lift and remove it

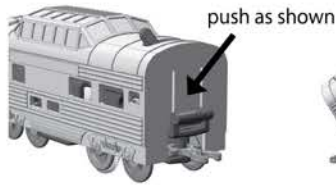

- 2 Insert battery minus side first as shown

Excessive force may damage batteries and this item

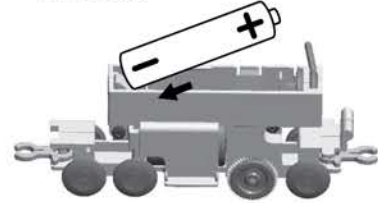

How to connect this item

Attach hooks as shown

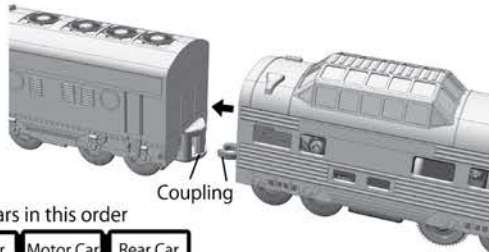

Attach cars in this order



How to turn on and off

Use the lever as shown

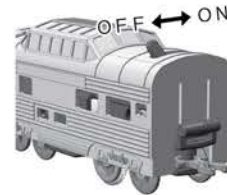

Use caution hair may become caught in this item's winding action

⚠ Caution

Please read before use and keep for reference

⚠ Train set safety

- 1 Do not ingest this item or give to children under 3 years of age
- 2 This item may have sharp edges and can cause injury to such things as eyes. Do not step on this item
- 3 Keep out of reach of children under 3 years of age
- 4 Supervise children who play with this item
- 5 Do not use near fire or heated place
- 6 Do not drop this item or use excessive force
- 7 Use caution when handling this item
- 8 This item is made of soft plastic and may bend with use. You may bend it back into shape

⚠ Motor car safety

Failure to configure battery correctly may result in damage

- 1 Do not use rechargeable batteries with this item
- 2 Insert the battery in its proper orientation
- 3 Remove battery when not in use
- 4 Do not push this item by hand, gears may be damaged
- 5 Follow battery label instructions
- 6 Use caution when changing batteries

Materials used

Train	Train Cover•Base•Wheels•Switch : Acrylonitrile butadiene styrene Hook: Polycarbonate Wheel: Rubber Gear: Polyacetal Axle•Battery ground•Screw: Steel
Structure	Main body : Polypropylene

*Size, shape and color may vary

MADE IN CHINA
SHANTOU CITY, GUANDONG PROVINCE.



⚠ WARNING:

CHOKING HAZARD — Small parts not for children under 3 years or any individuals who have a tendency to place inedible objects in their mouths.



LEC U.S.A. Corporation

One Bridge Plaza Fort Lee, NJ 07024, USA

<http://www.lecincusa.com>

Retain package and use it to store the entire diorama

How to assemble ※Attach as shown

Station

1 ※Connect the walls first

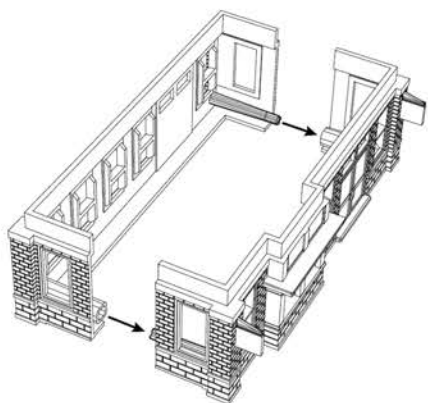

Tunnel

※Place tunnels carefully to improve the diorama

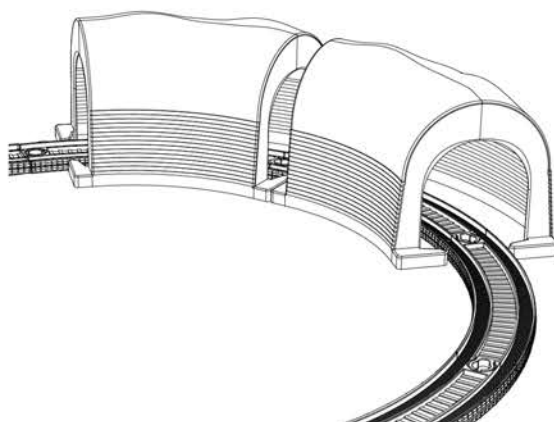
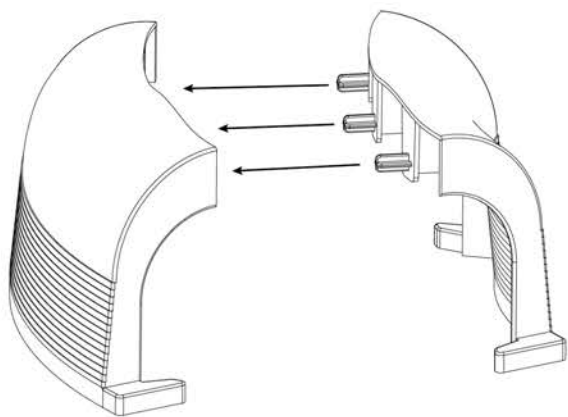

Steel bridge

1 ※Connect the top first

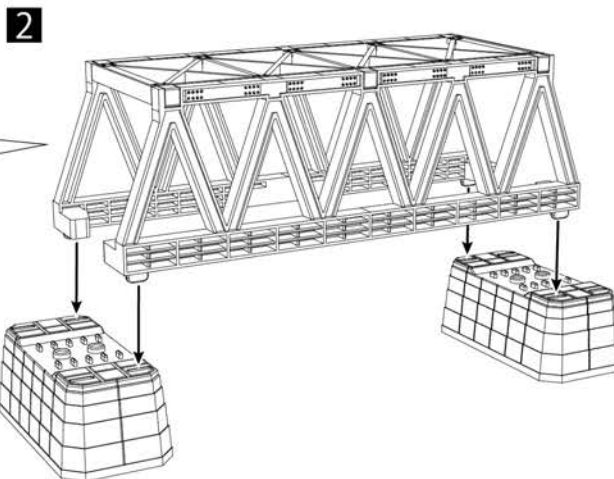
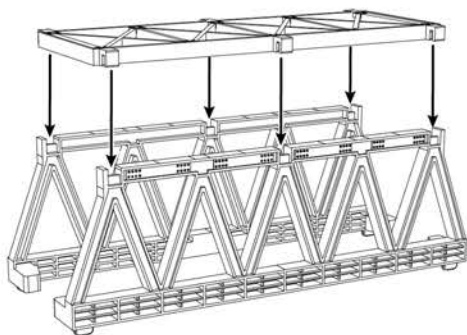

Station

Choose your favorite stickers for the station wall

Excessive force may damage batteries and this item

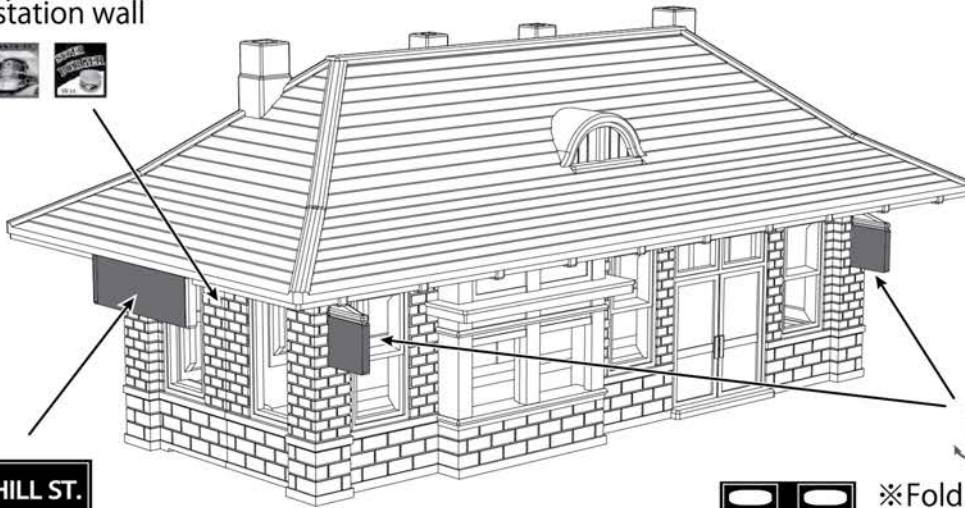

GOLD HILL ST.



※Fold and attach as shown

Tunnel

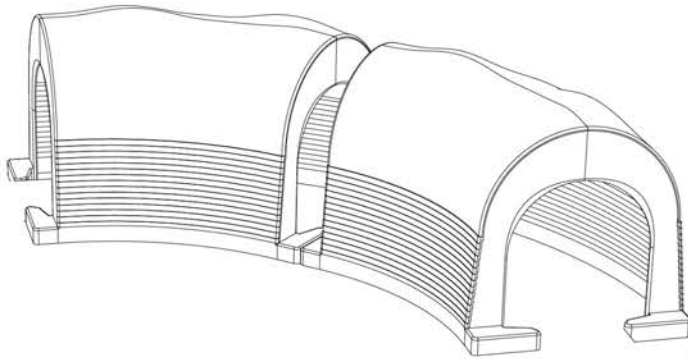

※Choose your favorite stickers to improve the diorama

Bridge column

